



## 04. PLÁSTICOS

TOLDOS, PLÁSTICOS, FUNDAS, REJILLAS...



# TOLDOS, PLÁSTICOS, FUNDAS...



Color verde

Medidas disponibles:  
3x6, 4x8, 4x12, 4x15, 5x10, 5x12, 5x15, 5x18,  
6x10, 6x12, 6x15, 6x16, 6x18, 8x18

**Toldos de malla confeccionados**



Colores: verde y negro  
Anchos: 200 y 400

**Tela sombreadora**

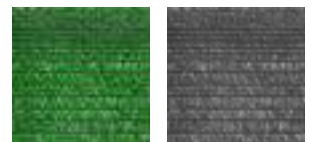

**Tela mosquitera**

Anchos: 100, 120 y 150 cm

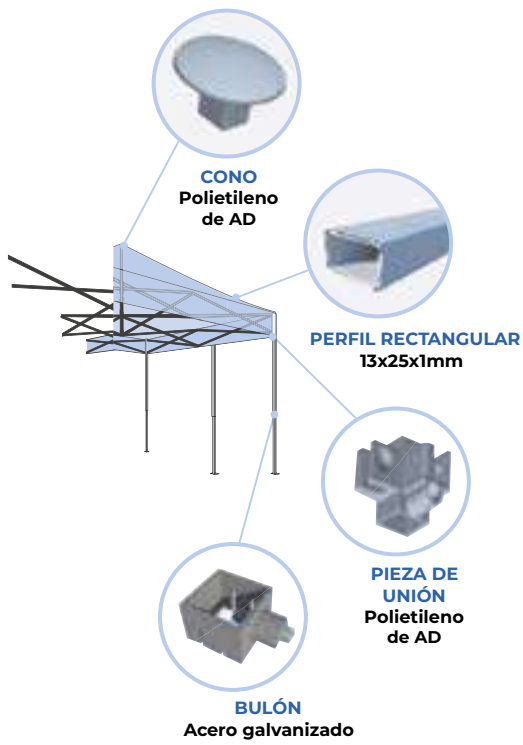

**MODELO BALINÉS**  
2x2, 2x3, 3x3, 3X6, 4X4, 4X6, 4X8 y 5x5 m.

**MODELO NOMAD**  
2x2, 2x3, 3x3, 3X6, 4X4, 4X6, 4X8 y 5x5 m.

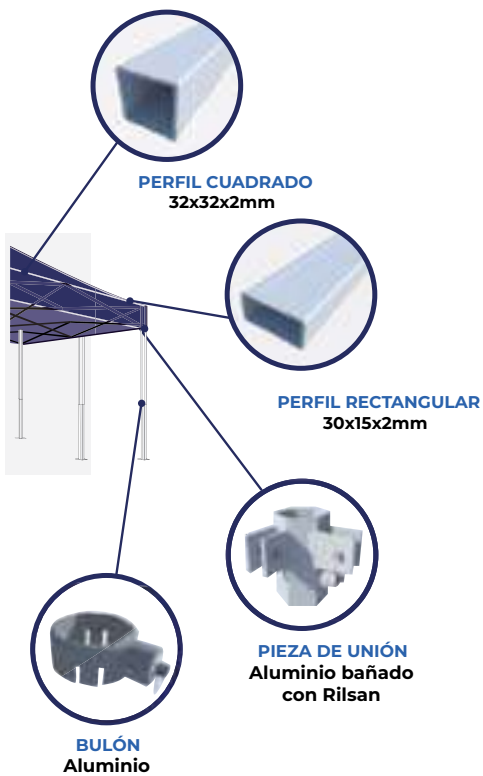

CARPAS



R-099 BLANCO / WHITE



R-117 CRUDO / RAW



R-415 MÁRMOL / MARBLE



R-180 ARENA / SAND



R-779 TWEED BEIGE / BEIGE TWEED



R-775 TWEED LINO / LINEN TWEED



R-161 GRIS / GREY



R-776-TWEED VISÓN / TAUPE TWEED



R-164 ANTRACITA / CHARCOAL GREY



R-103 NEGRO / BLACK



R-554 AMARILLO / YELLOW



R-567 NARANJA / ORANGE



R-176 ROJO / RED



R-177 BURDEOS / BURGUNDY



R-163 VERDE / GREEN



R-173 AZUL FUERTE / DARK BLUE



R-172 AZUL / BLUE



Lona acrílica toldo

Ancho: 120cm



Azul real



Marfil



Integral



Beige



Perla

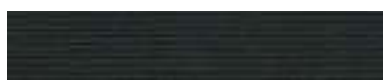

Negro



Azul marino

Ancho: 153cm

Lona star resinada impermeable



\* Blanco



Marfil



\* Beige



Champagne



Amarillo



Azafrán



Naranja



Rojo



Granate



\* Verde Claro



Musgo



\* Azul Claro



Marino



Silver



Gris Oscuro



Negro

\*En stock

Ancho: 300cm

Suntec



Blanco



Azul

Ancho: 220cm - 320 g/m<sup>2</sup>

Nautica Deck





**PVC  
SUPER TRANS**

Ancho: 250 cm



**PVC  
LOAD**

Ancho: 300 cm

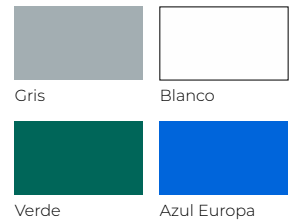

**Plástico toldo camión**

Poliéster recubierto de pvc 670 g/m<sup>2</sup>  
Disponibles en calidad ignífuga



Blanco



Beige



Verde



Azul



Gris



**Plástico Panama**

900 g/m<sup>2</sup>  
Ancho 300 cm



Bicolor Azul-negro



Ancho 250 cm

**Plástico piscinas**

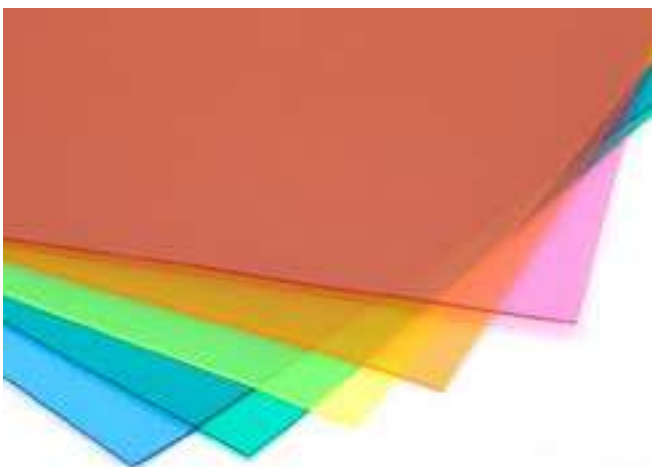

Ancho: 140 cm  
Grosor: 0'60mm  
Colores:  
Smoke, rojo, naranja,  
amarillo y rosa.

**Plástico transparente color**



Ancho: 137 y 150 cm

Grosos disponibles:  
0´20mm, 0´30mm, 0´50mm, 0´65mm, 1´00mm, 2´00mm, 3,00 mm

**Pvc transparente flexible**



**Disponible también en calidad ignífuga**



0´50mm

**Plástico serigrafiado para ventanas**



Ancho: 200 cm  
Grosor: 0´40mm

**Plástico transparente con membrana**



Poliétileno.  
Rollo continuo  
Medidas:  
- 70, 100, 125, i 150. Galga 150 g  
- 80 . galga 400 g  
- 210 galga 600 g

**Plástico transparente en tubo**

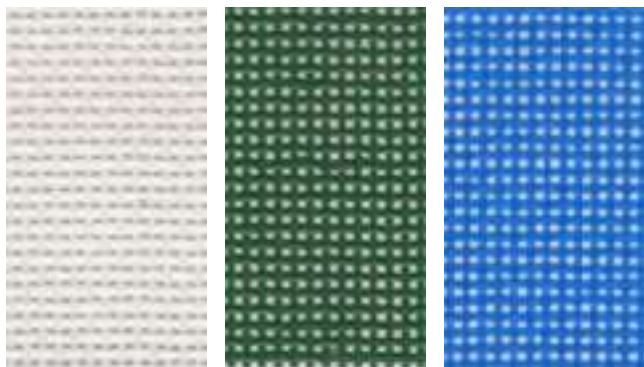

**Malla texlar 500**

Pvc Microperforada  
 Ancho: 200 cm  
 Peso: 220 g/m<sup>2</sup>  
 Colores: verde, blanco, azul

Malla texlar 500

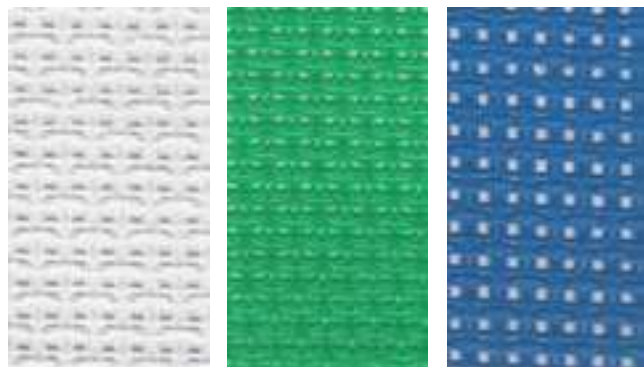

**Malla texlar 1000**

Pvc Microperforada  
 Ancho: 300 cm  
 Peso: 390 g/m<sup>2</sup>  
 Colores: verde, blanco, azul

Malla texlar 1000

# REJILLA 3D



**5D Moon**

100% poliéster  
 Ancho: 220cm  
 Peso: 380 g/m<sup>2</sup>  
 Espesor: 3 mm



**5D Oddity**

100% poliéster  
 Ancho: 220cm  
 Peso: 220 g/m<sup>2</sup> +/-10 g/m<sup>2</sup>  
 Espesor: 2 mm +/-0.3 mm



**5D Nemesis**

100% poliéster  
 Ancho: 220 cm  
 Peso: 170 g/m<sup>2</sup> +/-10 g/m<sup>2</sup>  
 Espesor: 2mm +/- 0.3 mm

5D PREMIUM



**Web Blanc**

100% PES  
 Ancho: 150cm  
 Peso: 355 g/m<sup>2</sup>  
 Espesor: 1mm



**Web Noir**

100% PES  
 Ancho: 150cm  
 Peso: 355 g/m<sup>2</sup>  
 Espesor: 1mm



**Web Beige**

100% PES  
 Ancho: 150cm  
 Peso: 355 g/m<sup>2</sup>  
 Espesor: 1mm

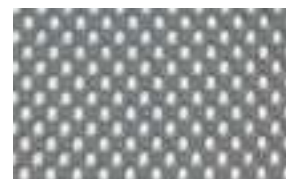

**Web Gris**

100% PES  
 Ancho: 150cm  
 Peso: 355 g/m<sup>2</sup>  
 Espesor: 1mm

4D WEB





BASIC 80



5D Carbón



BASIC 30



BASIC 40



BASIC 150



BASIC 130



BASIC 200



BASIC 210



BASIC 70



BASIC 110



BASIC 160



BASIC 50



BASIC 20



BASIC 10



BASIC 60

**3D BASIC**

100% poliéster.  
Ancho: 220cm

Peso: 160 g/m<sup>2</sup>  
Espesor: 2 - 2,5 mm



Namek 10



Namek 30



Namek 90



Namek 490



Namek 910



Namek 930

**NAMEK**

100% poliéster  
Ancho: 180 cm  
Peso: 282 g/m<sup>2</sup>

Espesor: 2 mm +/-  
0,3 mm



# APLICACIONES TÉCNICAS

PU, TPU, EVA, FOLIO PVC.

Para confección hospitalaria.

120, 170 y 200 g Extreme.  
Ancho: 220  
Grosor: 0'60mm

Colores: blanco y azul

Ignífugo, impermeable, transpirable y antibacterias



PU en rollo

Rollos de 100 y 150  $\mu$ m  
Ancho: 140 cm  
Colores: blanco y translúcido



Folio pvc

Para confección hospitalaria.

Rollos de 100 m  
Ancho: 140 cm  
Grosor: 100, 150 y 300  $\mu$ m

Colores: blanco y azul



TPU Termoplástico poliuretano

Colores: blanco y translúcido  
 Ancho: 140 cm  
 Grosor: 100 y 300 µm



**Folio técnico EVA**

Con protector de líquido y de partículas ambientales.

Composición: 100% PP + TPU  
 Lavable  
 Peso: 55gr  
 Ancho: 150 cm

**Tejido no tejido (TST)  
 + laminado TPU**



1 solo uso.  
 Con protector de líquidos y partículas ambientales.  
 Composición: 100% PP + PE  
 Peso: 55 gr.  
 Ancho: 160 cm

**Tejido no tejido  
 + laminado PE**



Para ara sector sanitario y téxtil.

60 grs.  
Ancho: 140 cm  
Color: azul y blanco

Composición: 58% poliuretano + 42% poliéster.



**PU impermeable antibacterias Q1**

Para confección hospitalaria.

60 grs.  
Ancho: 140 cm  
Color: blanco

Composición: 16% poliuretano + 42% poliéster  
+ 42% cloruro de polivinilo



**PU impermeable antibacterias Q2**

Ancho: 160 cm.  
Colores blanco y negro.  
Gramaje: 185 g

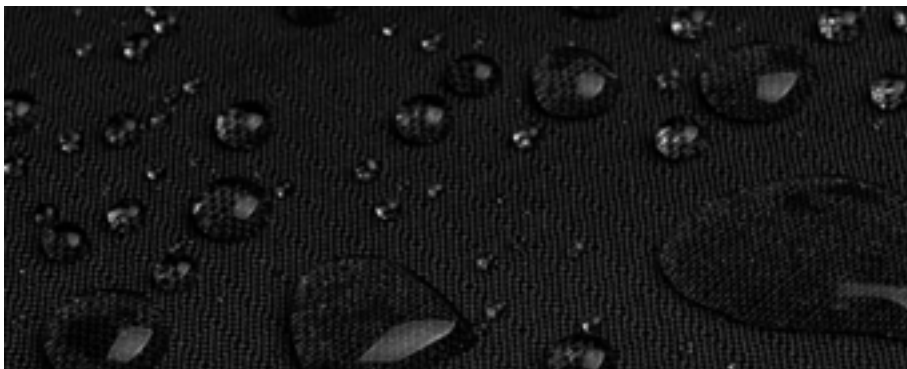

**PES resinado impermeable**





Para confección hospitalaria.  
Laminado en polietileno y tpu.  
Ancho: 160 cm



**TST laminado**

Apropiado para cortinas.

Poliéster impermeable.  
Ancho: 205 cm.  
Colores disponibles: rosa, blanco,  
beige, azul, verde.

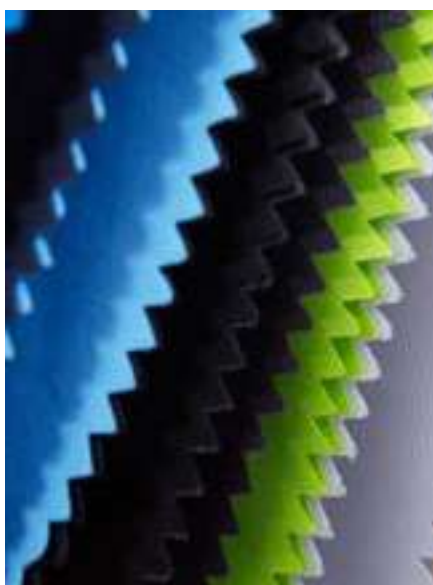

**Tejido de baño**